

Slide Rails / Slide Spacers

Plastic Type

Slide Rails



RoHS 10

HRLFLJ2
(For 2 Rows of 5mm Thick Plate)

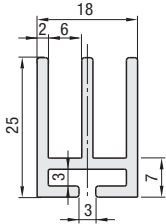

HRLFLJ3
(For 3 Rows of 5mm Thick Plate)

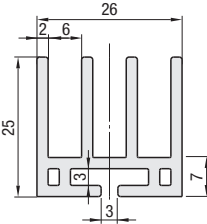

Use the Slide Rail Connectors to connect the Slide Rail to Aluminum Extrusions. Material: ABS Resin (Light Gray)

Part Number Type	No.	Length 1mm Increment	Extrusion (Series)	Mass kg/m	Unit Price/m
HRLFLJ	2	50-2000	HFS5	0.185	
	3		HFS6 HFS8(-45)	0.277	

Slide Rail Connectors



RoHS 10

HRLCN5

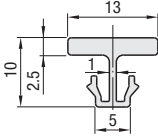

HRLCN6

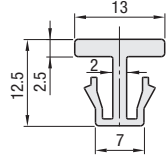

HRLCN8

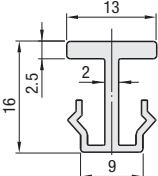

Used to connect the Slide Rails to the Aluminum Extrusions. Material: Polypropylene (Light Gray)

Part Number Type	No.	Length 1mm Increment	Extrusion (Series)	Mass kg/m	Unit Price/m
HRLCN	5	50-2000	HFS5	0.045	
	6		HFS6	0.064	
	8		HFS8(-45)	0.072	

Ordering Example

Part Number	-	Length
HRLFLJ3	-	1000
HRLCN6	-	1000

Example

Connection with Extrusion

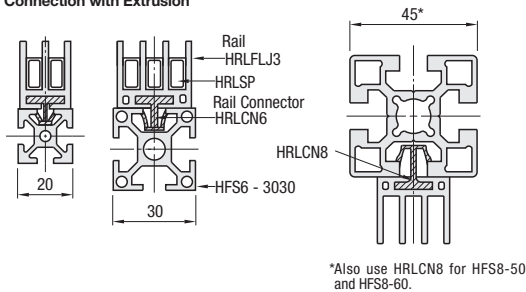

- Select HRLFLJ3 and HRLCN6 in order to attach 3-rows rail to the frames of HFS6 Series.

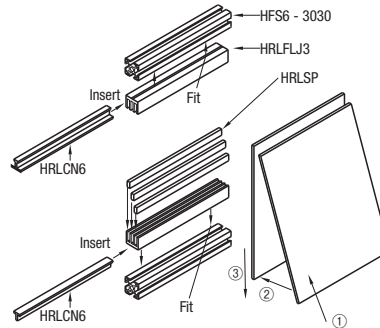

Post-assembly Side View

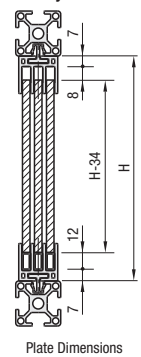

Slide Spacers



RoHS 10

HRLSP

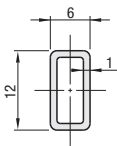

Example

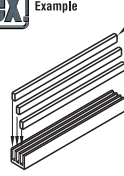

Type	Material	Heat Resistance Temperature
HRLSP	Polyethylene (Black)	-45 ~ 80°C

To be inserted into the lower rows of Slide Rails
Can be cut with scissors or a utility knife.

Part Number	Length mm	Unit Price 1 ~ 9 pc(s).	Volume Discount Rate 10-50	Part Number	Length mm	Unit Price (Set of 30 pcs.)
HRLSP	2000			HRLSP-SET (Set of 30 pcs.)	2000	

Ordering Example

Part Number	
HRLSP	
HRLSP-SET	