

Note that, for some of the types shown here, order might be unable to be received by the MISUMI Malaysia, and/or Indonesia offices.



Contact Probes, Receptacles

Minimum Mounting Pitch 2.54mm Series



Similar Component Page **P.1929**

Comparison Points with Similar Products | Replacement Cycle (Reference) : 200,000 times Convenient package sale is available at a low price.

Contact Probe
Sold by the package (50 pcs./pkg.)

Receptacle
Sold by the package (50 pcs./pkg.)

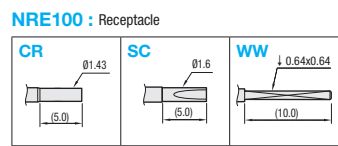
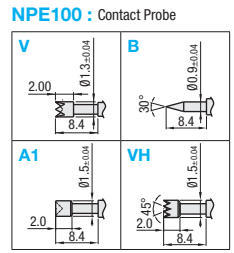

Contact Probes

Part	Material	Surface Treatment
(1) Plunger	BeCu	Gold Plating on Nickel Undercoat
(2) Barrel	Brass	Gold Plating on Nickel Undercoat
(3) Spring	SWP-A	Gold Plating on Nickel Undercoat

Receptacles

Material	Surface Treatment
Brass	Gold Plating on Nickel Undercoat

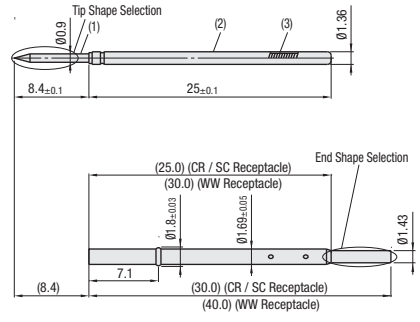

Contact Probe
Sold by the package (50 pcs./pkg.)

Receptacle
Sold by the package (50 pcs./pkg.)

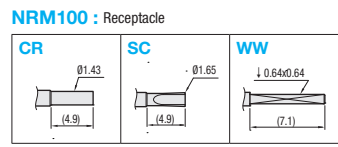
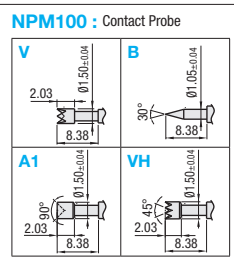

Contact Probes

Part	Material	Surface Treatment
(1) Plunger	SK4	Gold Plating on Nickel Undercoat
(2) Barrel	Brass	Gold Plating on Nickel Undercoat
(3) Spring	SUS304	-

Receptacles

Material	Surface Treatment
Brass	Gold Plating on Nickel Undercoat

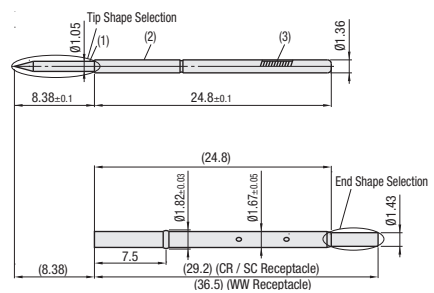

Contact Probe
Sold by the package (50 pcs./pkg.)

Receptacle
Sold by the package (50 pcs./pkg.)

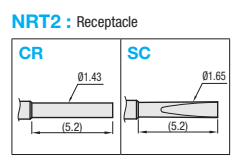
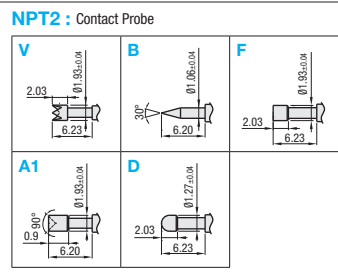

Contact Probes

Part	Material	Surface Treatment
(1) Plunger	SK4	Gold Plating on Nickel Undercoat
(2) Barrel	Brass	Gold Plating on Nickel Undercoat
(3) Spring	SWP-A	Gold Plating on Nickel Undercoat

Receptacles

Material	Surface Treatment
Brass	Gold Plating on Nickel Undercoat

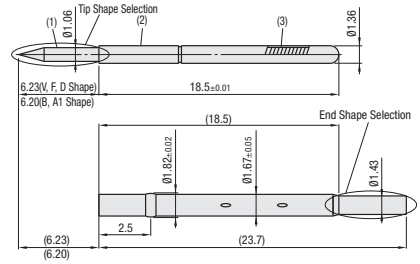

Contact Probes

Part Number	Tip Shape	Mounting Pitch (mm)	Full Stroke	Spring Pressure 2/3 Stroke	Allowable Current	Resistance	Replacement Cycle (Reference)	Unit Price (50 pcs./pkg.)	Tip Shape Price (Unit Price)
NPE100	V, B, A1, VH	2.54mm	6.4mm	284gf	3A	30mΩ	200,000 times		
NPM100	V, B, A1, VH	2.54mm	6.35mm	113gf	3A	50mΩ	200,000 times		
NPT2	V, B, A1, D, F	2.54mm	4.2mm	113gf	3A	50mΩ	200,000 times		

Receptacle

Part Number	Tip Shape	Matching Contact Probe	Mounting Hole for Press-Fitting Dimension (Reference)	Unit Price (50 pcs./pkg.)
NRE100	CR, SC, WW	NPE100	Ø1.75mm	
NRM100	CR, SC, WW	NPM100	Ø1.75mm	
NRT2	CR, SC	NPT2	Ø1.75mm	

Ordering Example

Part Number - Tip (End) Shape

NPT2 - V

NRM100 - SC