

外形図

■HLA-12AS (最適把持力 20N~50N)

HLA-12AS 標準

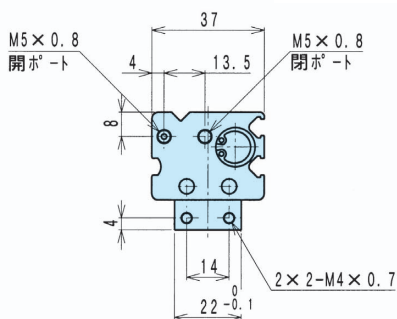
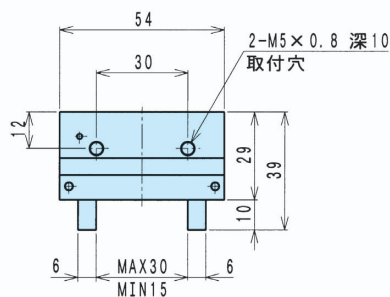
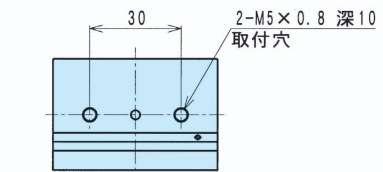

HLA-12AS-E□S□

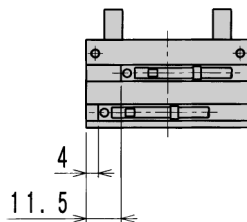

■HLA-15AS (最適把持力 40N~80N)

HLA-15AS 標準

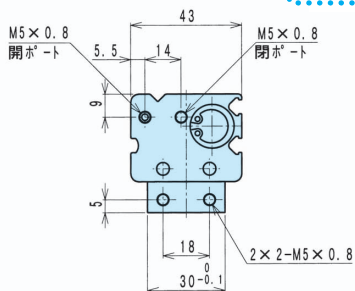
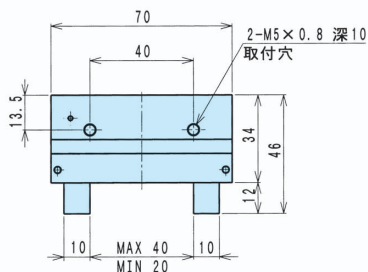
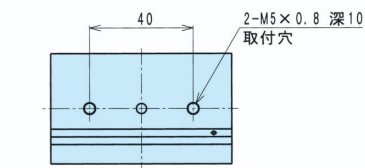

HLA-15AS-E□S□

